

MICROTECH LT-10 6CYL SEQUENTIAL ENGINE MANAGEMENT SYSTEM

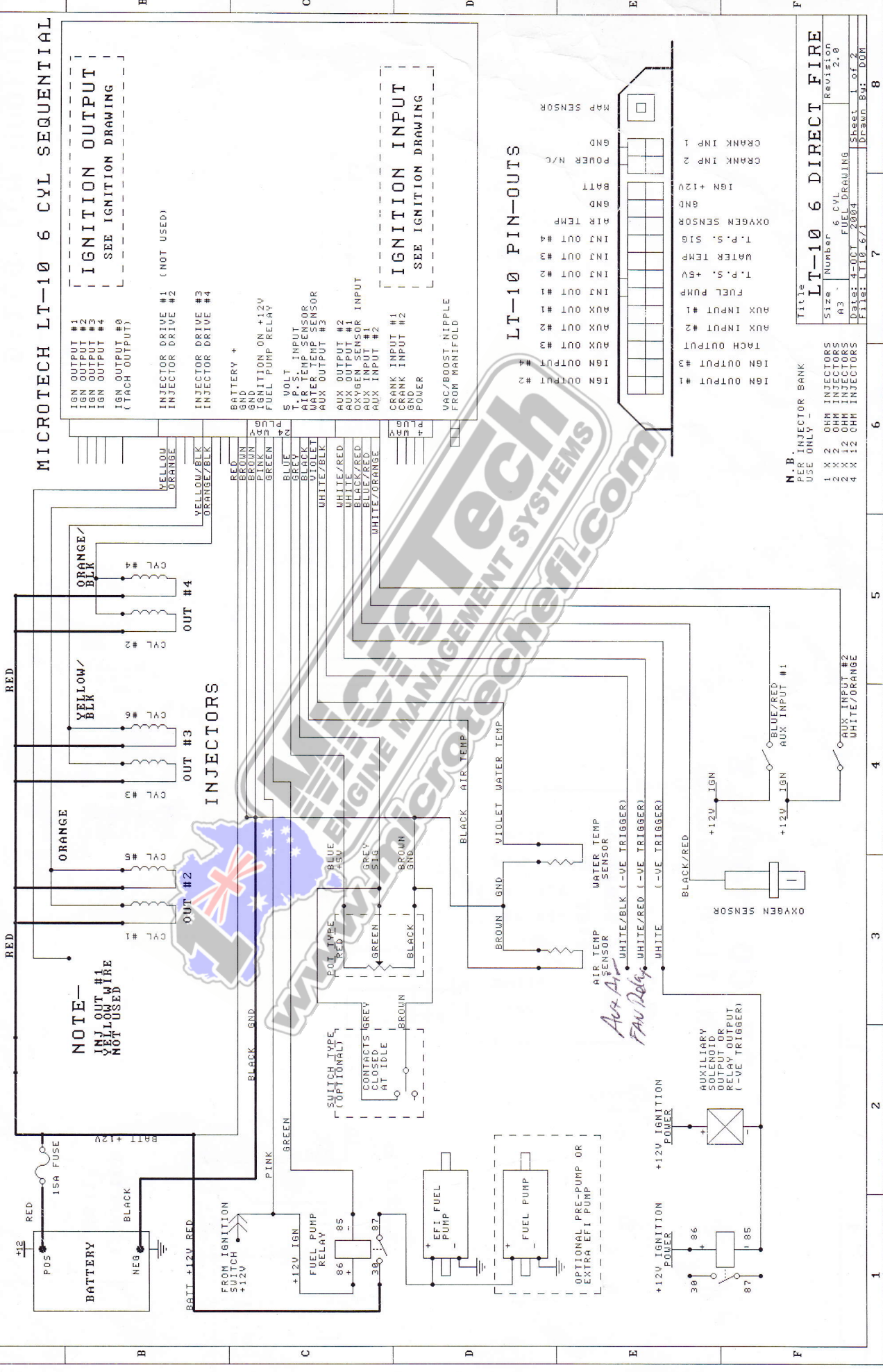

Title
LT-10 6 DIRECT FIRE

Size
Number 6 CYL
Revision 2.0

Date
4-00T 2004
Sheet 1 of 2
File: LT10.s/1
Drawn By: DOM

N.B.
PER INJECTOR BANK
USE ONLY -

- 1 X 2 OHM INJECTORS
- 2 X 2 OHM INJECTORS
- 2 X 12 OHM INJECTORS
- 4 X 12 OHM INJECTORS

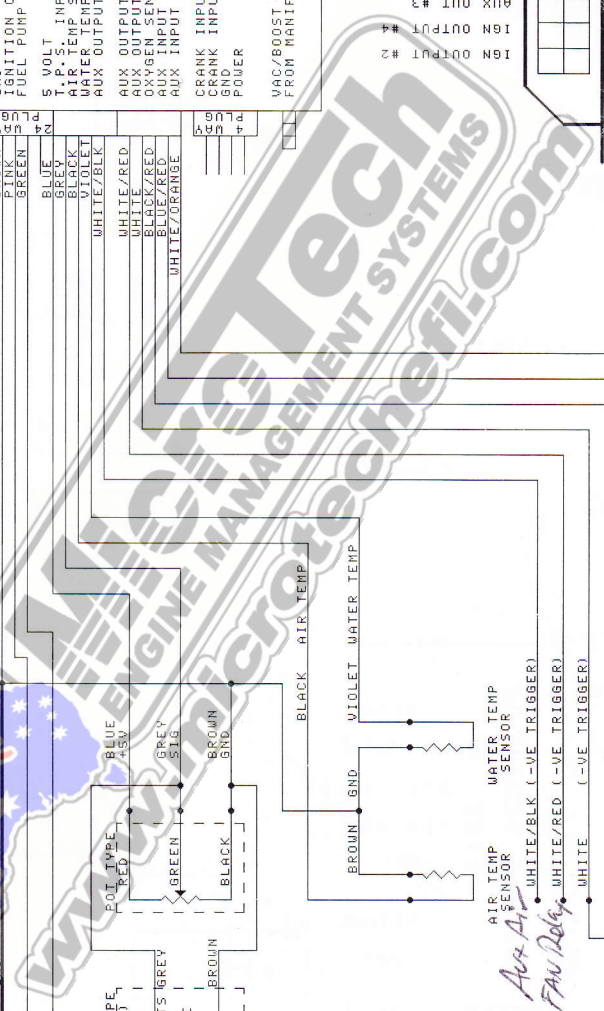

Act As Fuel Del

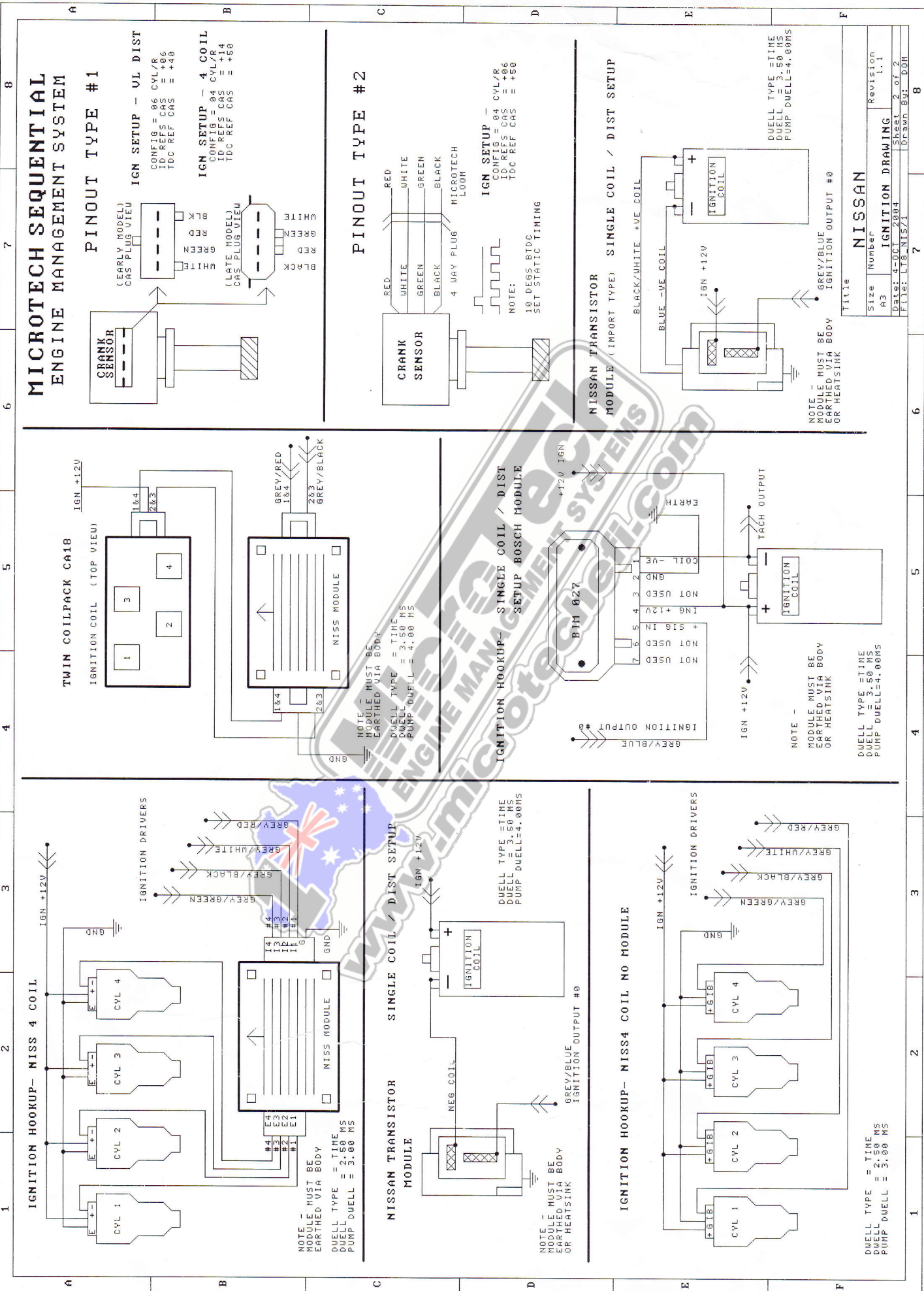

MICROTECH SEQUENTIAL ENGINE MANAGEMENT SYSTEM

PINOUT TYPE #1

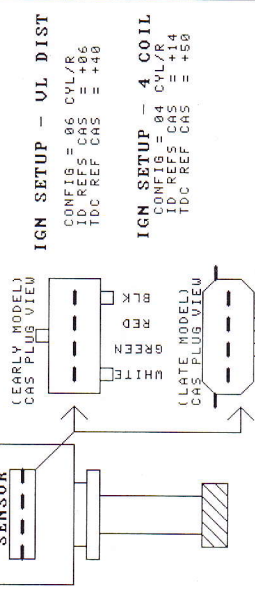

PINOUT TYPE #2

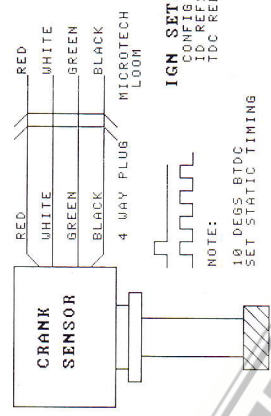

NISSAN TRANSISTOR MODULE (IMPORT TYPE) SINGLE COIL / DIST SETUP

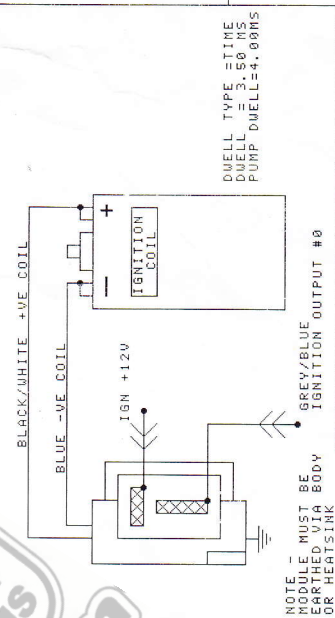

TWIN COILPACK CA18

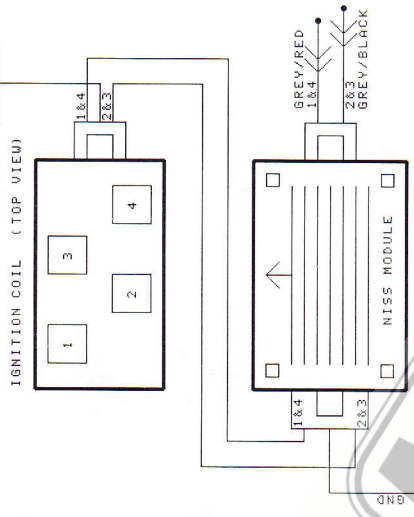

IGNITION HOOKUP- SINGLE COIL / DIST SETUP BOSCH MODULE

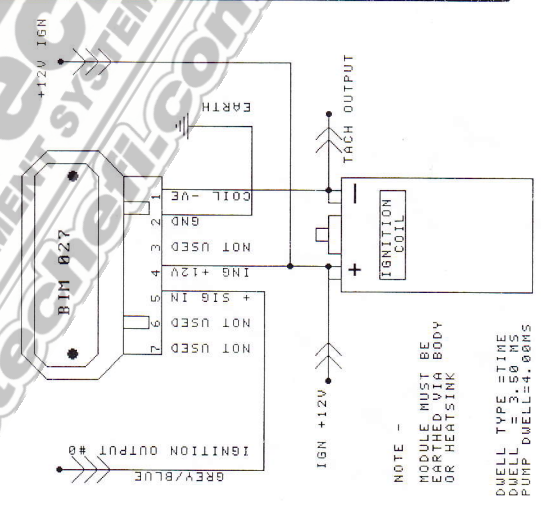

IGNITION HOOKUP- NISS 4 COIL

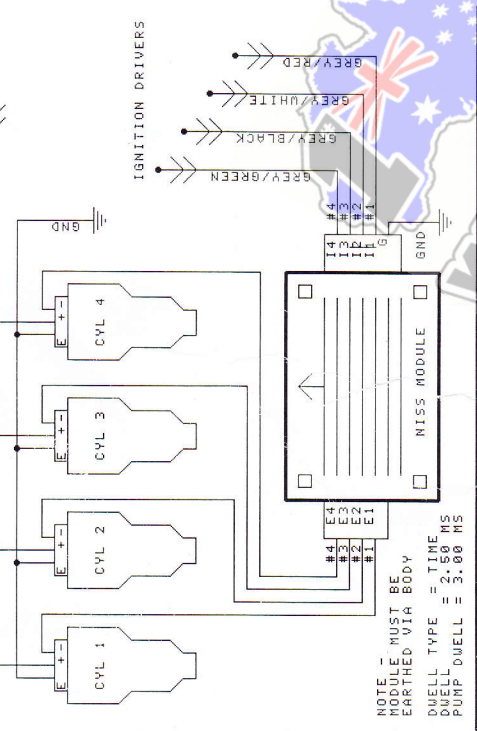

NISSAN TRANSISTOR MODULE

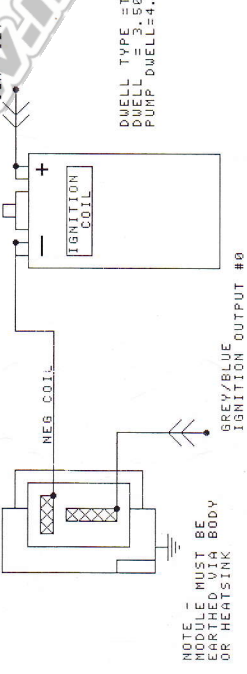

IGNITION HOOKUP- NISS 4 COIL NO MODULE

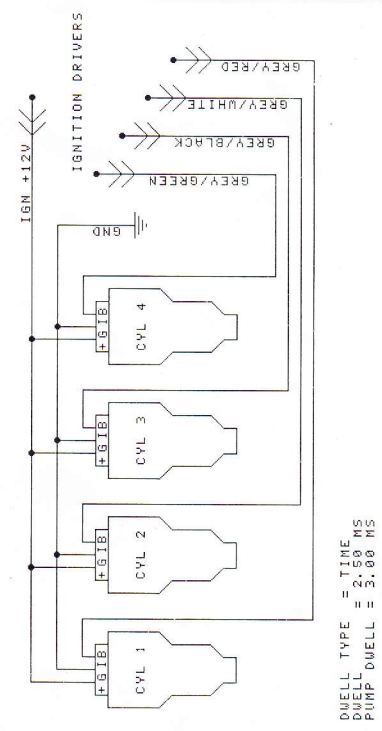

NISSAN

Size	Number	Revision
A3	IGNITION DRAWING	1.1
Date:	4-OCT-2004	Sheet 2 of 2
File:	L18_NIS/1	Drawn By: DDM